

REBSTOCK

Precision made in Germany

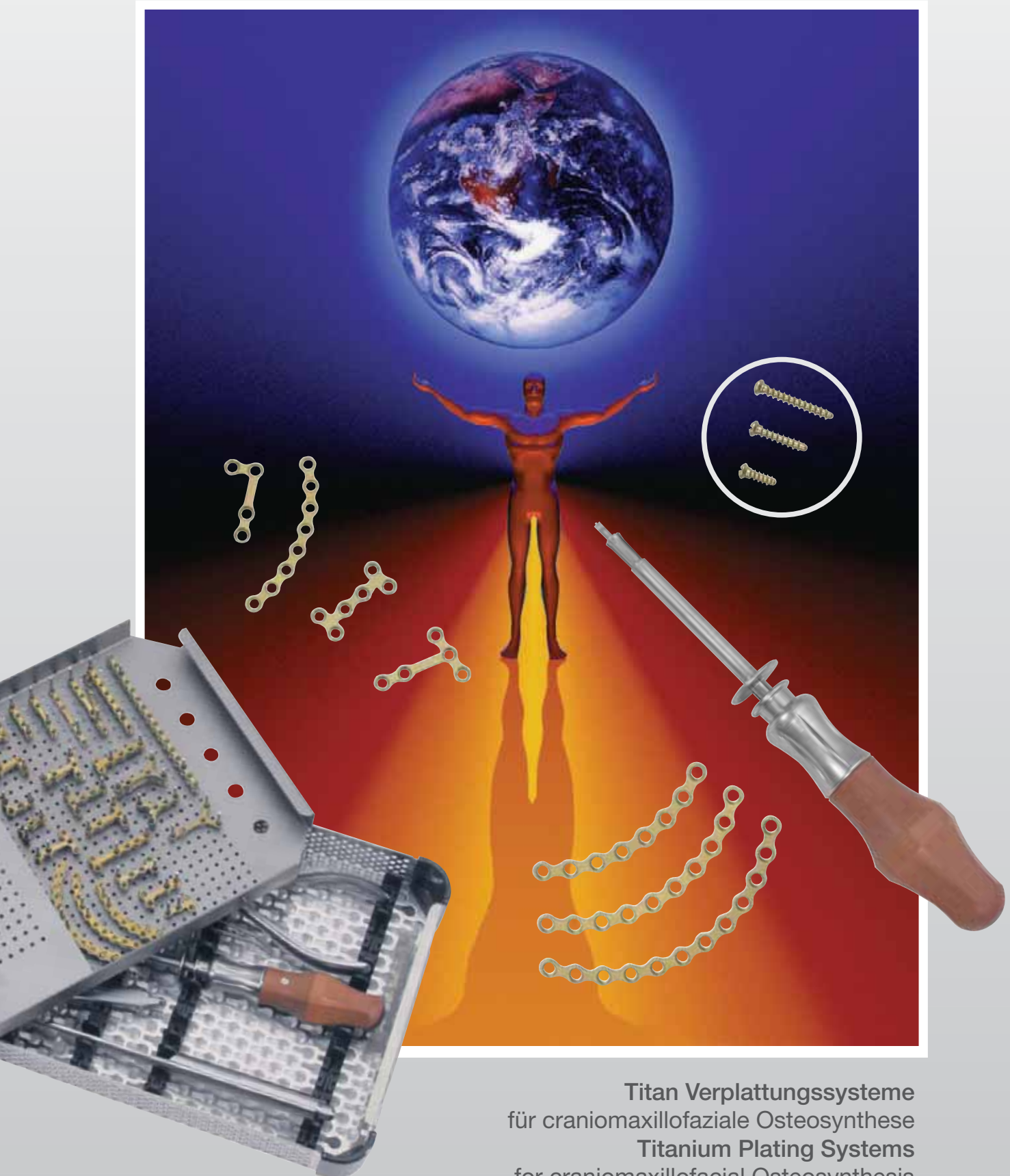

Titan Verplattungssysteme
für craniomaxillofaziale Osteosynthese
Titanium Plating Systems
for craniomaxillofacial Osteosynthesis

INDEX →

1,2 mm

Mikro-Platten-System / Micro Plate System	1-6
Standard-Set / Standard Set	1
Platten/ Plates	2-3
Schrauben / Screws	4
Instrumente / Instruments	5-6

1,7 mm

Medium-Platten-System / Medium Plate System	7-16
Standard-Set / Standard Set	7
Platten/ Plates	8-11
Schrauben / Screws	12
Instrumente / Instruments	13-16

2,0 mm

Mini-Platten-System / Mini Plate System	17-32
Standard-Set / Standard Set	17
Platten / Plates:	
Profil/Profile 0,6 mm	18-19
Profil/Profile 0,75 mm	20-21
Profil/Profile 1,0 mm	22-24
Schrauben / Screws	25-26
Instrumente / Instruments	27-32

2,3 mm

Fraktur-System	auf Anfrage
Fracture System	upon request

2,7 mm

Rekonstruktion System	auf Anfrage
Reconstruction System	upon request

Verpackungs- / Bestelleinheiten **Packing / Order quantity**



1 Stück / piece



5 Stück / pieces



10 Stück / pieces

Hinweis:

Die Verantwortlichkeit für die Auswahl und den Einsatz der Implantate durch ausreichend geschultes Fachpersonal obliegt dem behandelnden Arzt.

The responsibility for the selection and placement of the implants by properly trained personal fully applies to the surgeon.

1,2

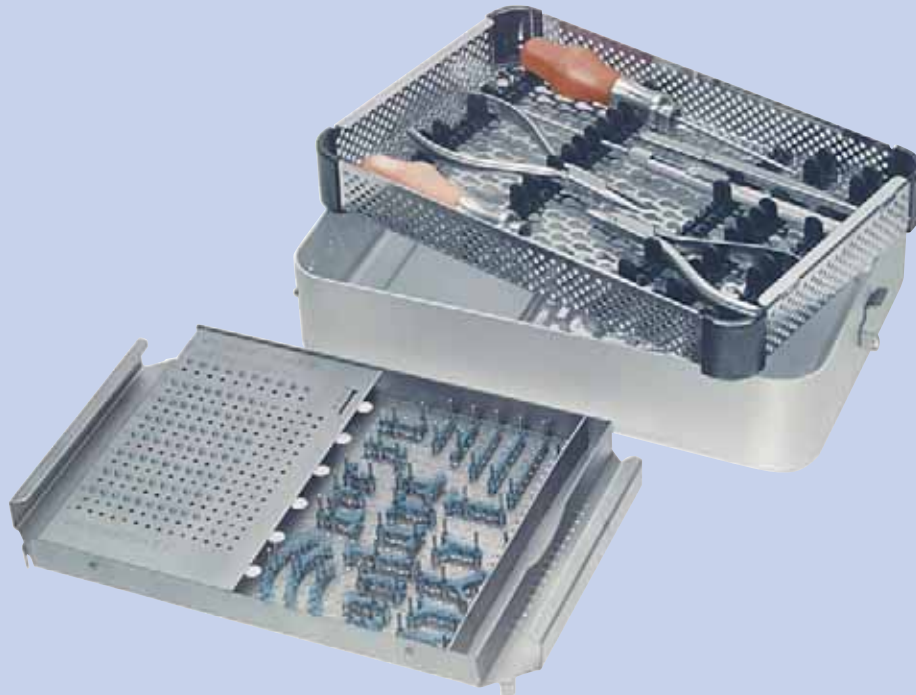

Artikel-Nr.
 Cat. No.

30 000	Mikro-Platten-Standard Set Standard Set Micro Plates komplett, bestehend aus: complete, consisting out of:
30 001	Sterilisier-Container 300 x 200 x 70 mm / Sterilisation Container 300 x 200 x 70 mm
30 002	Rack für Instrumente / Rack for instruments
30 003	Rack für Platten und Schrauben, TITAN Rack for plates and screws, TITANIUM
30 501	Plattenschneidezange mit Hartmetall, 12 cm Plate cutting pliers, with Tungsten Carbide inserts, 12 cm
30 502	Flachzange, 13,5 cm / Flat pliers, 13,5 cm
30 503	Plattenbiegezange ADERER, 13 cm Plate bending pliers ADERER, 13 cm
30 505	Platten/Schrauben-Haltepinzette, TITAN, 15 cm Plates and screws holding forceps, TITANIUM, 15 cm
30 510	Schraubendreher selbsthaltend, 18 cm, für Kreuzschlitzschrauben Screw-driver, self-holding, 18 cm, for cross head screws
30 525	1x Spiralbohrer ø 1,0 x 46 mm mit Stryker-Ansatz 1x Twist drill ø 1,0 x 46 mm with Stryker Coupling
30 526	1x Spiralbohrer ø 1,0 x 50 mm mit Stryker-Ansatz 1x Twist drill ø 1,0 x 50 mm with Stryker Coupling

Artikel-Nr.
 Cat. No.

Platten, je 5 Stück / Plates, 5 each:

30 101	4-Loch / 4 holes
30 102	6-Loch / 6 holes
30 103	8-Loch / 8 holes
30 104	12-Loch / 12 holes
30 105	16-Loch / 16 holes
30 106	24-Loch / 24 holes
30 107	5-Loch, rechts / 5 holes, right
30 108	5-Loch, links / 5 holes, left
30 109	8-Loch, rechts / 8 holes, right
30 110	8-Loch, links / 8 holes, left
30 111	5-Loch, 90° / 5 holes, 90°
30 112	7-Loch, 90° / 7 holes, 90°
30 113	6-Loch / 6 holes
30 114	6-Loch / 6 holes
30 115	7-Loch / 7 holes
30 116	9-Loch / 9 holes
30 117	Orbita-Platte, 8-Loch / Orbital Plate, 8 holes

Schrauben, je 10 Stück / Screws, 10 each:

30 303	ø 1,2 x 4 mm
30 304	ø 1,2 x 5 mm
30 305	ø 1,2 x 6 mm
30 306	ø 1,2 x 7 mm
30 307	ø 1,2 x 8 mm
30 308	ø 1,2 x 9 mm
30 310	ø 1,2 x 11 mm
30 314	ø 1,4 x 5 mm Notfallschraube/Emergency screw

Gerne können Sie Ihr individuelles Set zusammenstellen.
 Wir passen die Lagerungsracks entsprechend an.

You can always compose your individual set.
 We will adapt the racks accordingly.

5



Nr./No.:

30 101
4-Loch
4 holes

30 102
6-Loch
6 holes

30 103
8-Loch
8 holes

30 104
12-Loch
12 holes

30 105
16-Loch
16 holes

30 106
24-Loch
24 holes

5



Nr./No.:

30 107
5-Loch, rechts
5 holes, right

30 108
5-Loch, links
5 holes, left

30 109
8-Loch, rechts
8 holes, right

30 110
8-Loch, links
8 holes, left

30 111
5-Loch, 90°
5 holes, 90°

30 112
7-Loch, 90°
7 holes, 90°

5



Nr./No.:

30 113
6-Loch
6 holes

30 114
6-Loch
6 holes

30 115
7-Loch
7 holes

30 116
9-Loch
9 holes

30 117
Orbita-Platte 8-Loch
Orbital Plate 8 holes

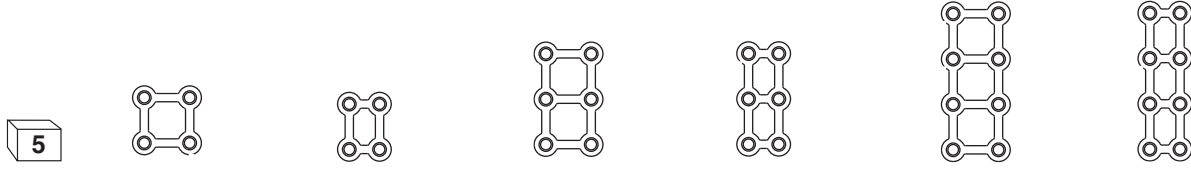

Nr./No.:	30 118 2x2-Loch 2x2 holes	30 119 2x2-Loch 2x2 holes	30 120 3x2-Loch 3x2 holes	30 121 3x2-Loch 3x2 holes	30 122 4x2-Loch 4x2 holes	30 123 4x2-Loch 4x2 holes
----------	--	--	--	--	--	--

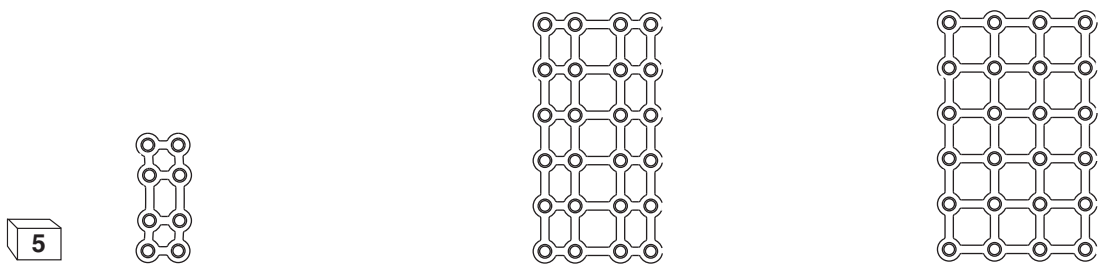

Nr./No.:	30 124 4x2-Loch, Zygoma 4x2 holes, Zygoma	30 125 6x4-Loch 6x4 holes	30 126 6x4-Loch 6x4 holes
----------	--	--	--



Artikel-Nr.
Cat. No.

Gitter-Platten, TITAN
Mesh Plates, TITANIUM

30 251	60 x 60 x 0,1 mm
30 252	120 x 60 x 0,1 mm
30 253	120 x 120 x 0,1 mm
30 254	60 x 60 x 0,2 mm
30 255	120 x 60 x 0,2 mm
30 256	120 x 120 x 0,2 mm



Artikel-Nr.
Cat. No.

Gitter-Platten, TITAN
Mesh Plates, TITANIUM

30 257	80 x 50 x 0,3 mm
30 258	80 x 50 x 0,6 mm

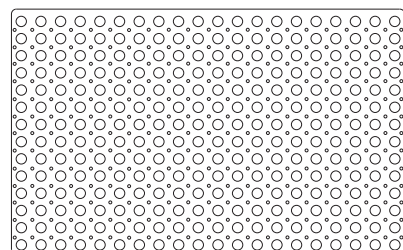



Artikel-Nr.
Cat. No.

Kreuzschlitz
Cross head

30 301	ø 1,2 x 2 mm
30 302	ø 1,2 x 3 mm
30 303	ø 1,2 x 4 mm
30 304	ø 1,2 x 5 mm
30 305	ø 1,2 x 6 mm
30 306	ø 1,2 x 7 mm
30 307	ø 1,2 x 8 mm
30 308	ø 1,2 x 9 mm
30 309	ø 1,2 x 10 mm
30 310	ø 1,2 x 11 mm
30 311	ø 1,2 x 12 mm
30 312	ø 1,2 x 13 mm

Notfallschrauben
Emergency screws

30 313	ø 1,4 x 3 mm
30 314	ø 1,4 x 5 mm
30 315	ø 1,4 x 7 mm



Artikel-Nr.
Cat. No.

Vierkant
Square head

30 320	ø 1,2 x 2 mm
30 321	ø 1,2 x 3 mm
30 322	ø 1,2 x 4 mm
30 323	ø 1,2 x 5 mm
30 324	ø 1,2 x 6 mm
30 325	ø 1,2 x 7 mm
30 326	ø 1,2 x 8 mm

Notfallschrauben
Emergency screws

30 327	ø 1,4 x 3 mm
30 328	ø 1,4 x 5 mm

Artikel-Nr.
Cat. No.

30 501 Plattenschneidezange
12 cm, mit Hartmetall
Plate cutting pliers
12 cm, with Tungsten Carbide inserts



Artikel-Nr.
Cat. No.

30 502 Flachzange, 13,5 cm
Flat pliers, 13,5 cm



Artikel-Nr.
Cat. No.

30 503 Plattenbiegezange ADERER, 13 cm
Plate bending pliers ADERER, 13 cm



Artikel-Nr.
Cat. No.

30 505 Platten/Schrauben-Haltepinzette,
TITAN, 15 cm
Plates and screws holding forceps
TITANIUM, 15 cm





Artikel-Nr.
Cat. No.

30 510 Schraubendreher, 18 cm
selbsthaltend, für Kreuzschlitzschrauben
Screw-driver, 18 cm
self-holding, for cross head screws



30 511 Schraubendreher, 18 cm
selbsthaltend, für Vierkantschrauben
Screw-driver, 18 cm
self-holding, for square head screws



Artikel-Nr.
Cat. No.

30 513 Schraubendrehergriff
alleine, für alle Klingen
Screw-driver handle
only, for all blades



Artikel-Nr.
Cat. No.

30 514 Schraubendreherklinge
alleine, selbsthaltend, für Kreuzschlitzschrauben
Screw-driver blade
only, self-holding, for cross head screws



30 515 Schraubendreherklinge
alleine, selbsthaltend, für Vierkantschrauben
Screw-driver blade
only, self-holding, for square head screws



Artikel-Nr.
Cat. No.

Spiralbohrer mit Stryker-Ansatz
Twist Drill with Stryker Coupling

30 525 ø 1,0 x 46 mm
für Schrauben bis 4 mm Länge
for screws up to 4 mm length

30 526 ø 1,0 x 50 mm
für Schrauben bis 8 mm Länge
for screws up to 8 mm length

Spiralbohrer mit Dental-Ansatz
Twist Drill with Dental Coupling

30 527 ø 1,0 x 30 mm
für Schrauben bis 4 mm Länge
for screws up to 4 mm length

30 528 ø 1,0 x 34 mm
für Schrauben bis 8 mm Länge
for screws up to 8 mm length

1,7



Artikel-Nr.
 Cat. No.

- 31 000** Medium-Platten-Standard Set
 Standard Set Medium Plates
 komplett, bestehend aus:
 complete, consisting out of:
- 31 001** Sterilisier-Container 300 x 200 x 70 mm
 Sterilisation Container 300 x 200 x 70 mm
 - 31 002** Rack für Instrumente / Rack for instruments
 - 31 003** Rack für Platten und Schrauben, TITAN
 Rack for plates and screws, TITANIUM
 - 31 501** Plattenschneidezange, mit Hartmetall, 12 cm
 Plate cutting pliers, with Tungsten Carbide inserts, 12 cm
 - 31 502** Flachzange, 13,5 cm / Flat pliers, 13,5 cm
 - 31 503** Plattenbiegezange ADERER, 13 cm
 Plate bending pliers ADERER, 13 cm
 - 31 505** Platten/Schrauben-Haltepinzette, TITAN, 15 cm
 Plates and screws holding forceps, TITANIUM, 15 cm
 - 31 507** Schraubendreher selbsthaltend, 18 cm,
 für Kreuzschlitzschrauben
 Screw-driver, self-holding, 18 cm, for cross head screws
 - 31 525** 1x Spiralbohrer ø 1,3 x 47 mm mit Stryker-Ansatz
 1x Twist drill ø 1,3 x 47 mm with Stryker Coupling
 - 31 526** 1x Spiralbohrer ø 1,3 x 50 mm mit Stryker-Ansatz
 1x Twist drill ø 1,3 x 50 mm with Stryker Coupling

Platten, je 5 Stück / Plates, 5 each:

- 31 103** 4-Loch / 4 holes
- 31 104** 4-Loch / 4 holes
- 31 105** 4-Loch / 4 holes

Artikel-Nr.
 Cat. No.

- 31 106** 4-Loch / 4 holes
- 31 107** 6-Loch / 6 holes
- 31 109** 8-Loch / 8 holes
- 31 110** 16-Loch / 16 holes
- 31 111** 18-Loch / 18 holes
- 31 112** 30-Loch / 30 holes
- 31 115** 4-Loch, rechts / 4 holes, right
- 31 116** 4-Loch, links / 4 holes, left
- 31 117** 4-Loch, rechts / 4 holes, right
- 31 118** 4-Loch, links / 4 holes, left
- 31 123** 4-Loch / 4 holes
- 31 124** 4-Loch / 4 holes
- 31 125** 6-Loch / 6 holes
- 31 128** 5-Loch / 5 holes
- 31 129** 5-Loch / 5 holes
- 31 131** 6-Loch / 6 holes
- 31 132** 6-Loch / 6 holes
- 31 133** 7-Loch / 7 holes
- 31 135** Orbita-Platte, 6-Loch / Orbital Plates, 6 holes
- 31 136** Orbita-Platte, 8-Loch / Orbital Plates, 8 holes

Schrauben, je 10 Stück / Screws, 10 each:

- 31 301** ø 1,7 x 3 mm
- 31 302** ø 1,7 x 4 mm
- 31 303** ø 1,7 x 5 mm
- 31 304** ø 1,7 x 6 mm
- 31 305** ø 1,7 x 7 mm
- 31 306** ø 1,7 x 8 mm
- 31 307** ø 1,9 x 5 mm Notfallschraube/Emergency screw

Gerne können Sie Ihr individuelles Set zusammenstellen.
 Wir passen die Lagerungsracks entsprechend an.

You can always compose your individual set.
 We will adapt the racks accordingly.

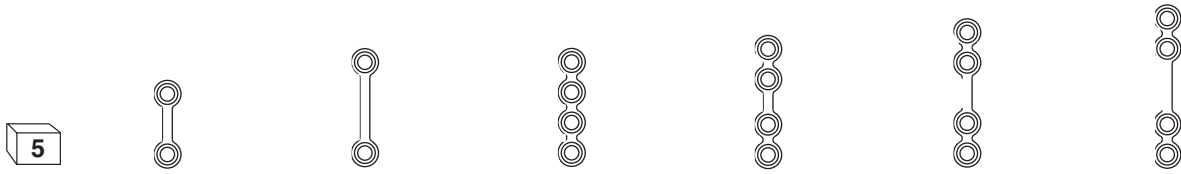

Nr./No.:	31 101 2-Loch 2 holes	31 102 2-Loch 2 holes	31 103 4-Loch 4 holes	31 104 4-Loch 4 holes	31 105 4-Loch 4 holes	31 106 4-Loch 4 holes
----------	------------------------------------	------------------------------------	------------------------------------	------------------------------------	------------------------------------	------------------------------------

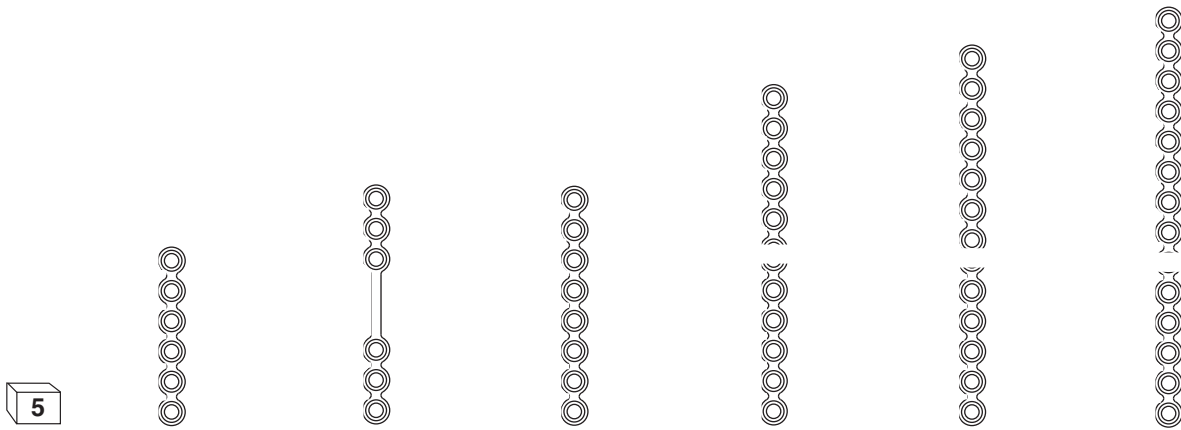

Nr./No.:	31 107 6-Loch 6 holes	31 108 6-Loch 6 holes	31 109 8-Loch 8 holes	31 110 16-Loch 16 holes	31 111 18-Loch 18 holes	31 112 30-Loch 30 holes
----------	------------------------------------	------------------------------------	------------------------------------	--------------------------------------	--------------------------------------	--------------------------------------

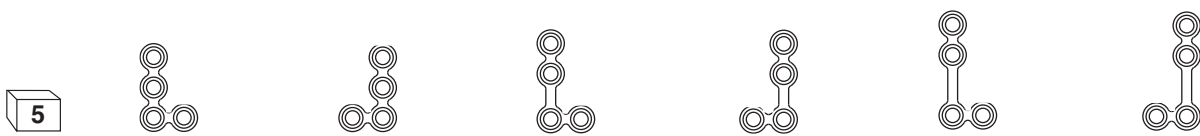

Nr./No.:	31 113 4-Loch, rechts 4 holes, right	31 114 4-Loch, links 4 holes, left	31 115 4-Loch, rechts 4 holes, right	31 116 4-Loch, links 4 holes, left	31 117 4-Loch, rechts 4 holes, right	31 118 4-Loch, links 4 holes, left
----------	---	---	---	---	---	---

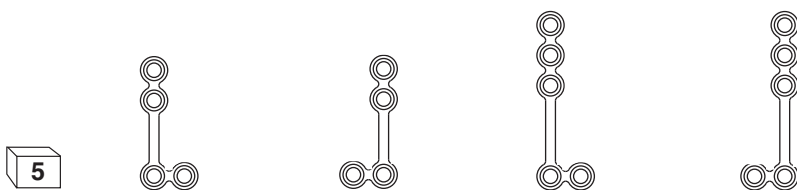

Nr./No.:	31 119 4-Loch, rechts 4 holes, right	31 120 4-Loch, links 4 holes, left	31 121 5-Loch, rechts 5 holes, right	31 122 5-Loch, links 5 holes, left
----------	---	---	---	---

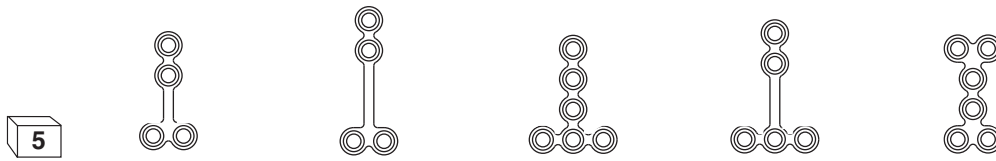

Nr./No.:	31 123 4-Loch 4 holes	31 124 4-Loch 4 holes	31 125 6-Loch 6 holes	31 126 5-Loch 5 holes	31 127 6-Loch 6 holes
----------	------------------------------------	------------------------------------	------------------------------------	------------------------------------	------------------------------------

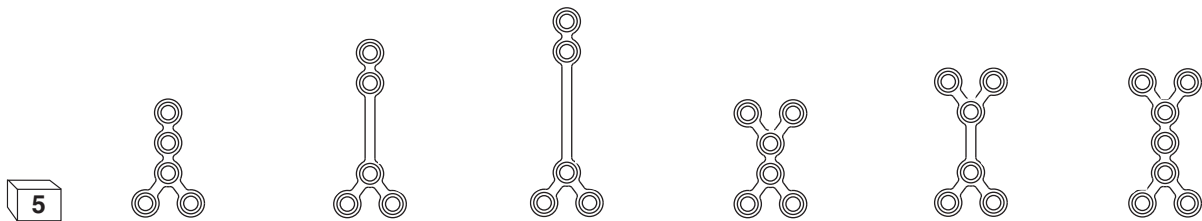

Nr./No.:	31 128 5-Loch 5 holes	31 129 5-Loch 5 holes	31 130 5-Loch 5 holes	31 131 6-Loch 6 holes	31 132 6-Loch 6 holes	31 133 7-Loch 7 holes
----------	------------------------------------	------------------------------------	------------------------------------	------------------------------------	------------------------------------	------------------------------------



Nr./No.:	31 134 4-Loch 4 holes	31 135 6-Loch 6 holes	31 136 8-Loch 8 holes	31 137 10-Loch 10 holes
----------	------------------------------------	------------------------------------	------------------------------------	--------------------------------------

für Trepanation
 for trepanation

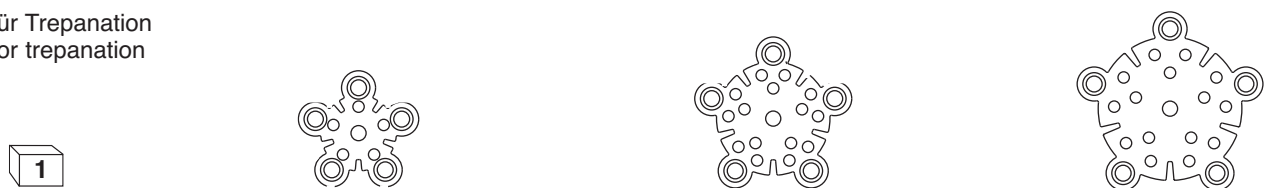

Nr./No.:	31 138 ø 7 mm ø 7 mm	31 139 ø 10 mm ø 10 mm	31 140 ø 14 mm ø 14 mm
----------	-----------------------------------	-------------------------------------	-------------------------------------

5

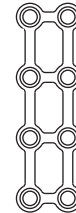
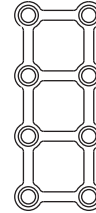
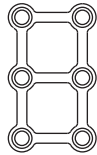

Nr./No.:

31 141
2x2-Loch
2x2 holes

31 142
2x2-Loch
2x2 holes

31 143
3x2-Loch
3x2 holes

31 144
3x2-Loch
3x2 holes

31 145
4x2-Loch
4x2 holes

31 146
4x2-Loch
4x2 holes

1

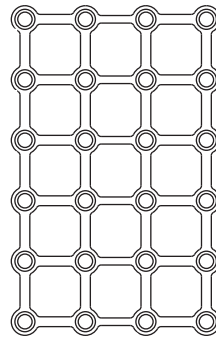
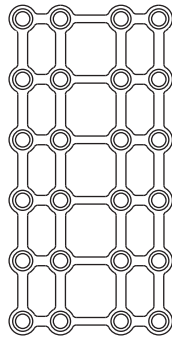

Nr./No.:

31 147
6x4-Loch
6x4 holes

31 148
6x4-Loch
6x4 holes

1

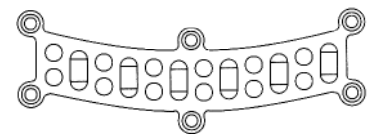
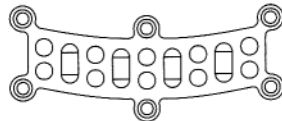
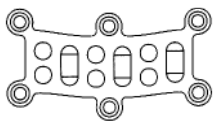

Nr./No.:
Neuro-Spaltenplatten
Neuro gap plates

31 149

31 150

31 151



Artikel-Nr.
 Cat. No.

31 152

Neuro Sub-temporale Platte
 Neuro sub temporal plate

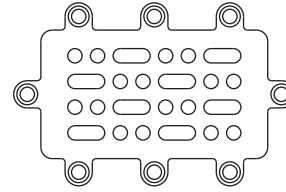

Artikel-Nr.
 Cat. No.

31 153

Neuro Sub-temporale Platte
 Neuro sub temporal plate

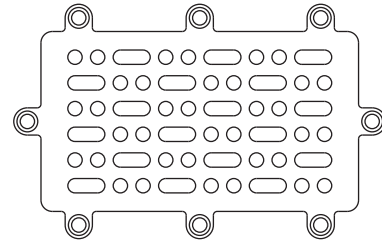

Artikel-Nr.
 Cat. No.

**Gitter-Platten, TITAN
 Mesh Plates, TITANIUM**

31 251

60 x 60 x 0,1 mm

31 252

120 x 60 x 0,1 mm

31 253

120 x 120 x 0,1 mm

31 254

60 x 60 x 0,2 mm

31 255

120 x 60 x 0,2 mm

31 256

120 x 120 x 0,2 mm

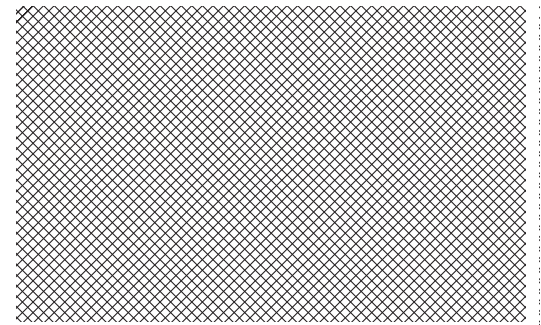

Artikel-Nr.
 Cat. No.

**Gitter-Platten, TITAN
 Mesh Plates, TITANIUM**

31 257

80 x 50 x 0,3 mm

31 258

80 x 50 x 0,6 mm

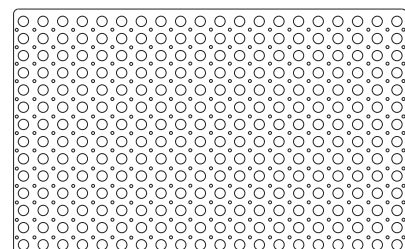



Artikel-Nr.
Cat. No.

Kreuzschlitz
Cross head

31 301	ø 1,7 x 3 mm
31 302	ø 1,7 x 4 mm
31 303	ø 1,7 x 5 mm
31 304	ø 1,7 x 6 mm
31 305	ø 1,7 x 7 mm
31 306	ø 1,7 x 8 mm

Notfallschraube
Emergency screw

31 307	ø 1,9 x 5 mm
---------------	--------------



Artikel-Nr.
Cat. No.

Vierkant
Square head

31 308	ø 1,7 x 3 mm
31 309	ø 1,7 x 4 mm
31 310	ø 1,7 x 5 mm
31 311	ø 1,7 x 6 mm
31 312	ø 1,7 x 7 mm
31 313	ø 1,7 x 8 mm
31 314	ø 1,7 x 9 mm
31 315	ø 1,7 x 11 mm
31 316	ø 1,7 x 13 mm
31 317	ø 1,7 x 15 mm

Notfallschrauben
Emergency screws

31 318	ø 1,9 x 5 mm
31 319	ø 1,9 x 7 mm

Artikel-Nr.
Cat. No.

31 501 Plattenschneidezange
12 cm, mit Hartmetall
Plate cutting pliers
12 cm, with Tungsten Carbide inserts



Artikel-Nr.
Cat. No.

31 502 Flachzange, 13,5 cm
Flat pliers, 13,5 cm



Artikel-Nr.
Cat. No.

31 503 Plattenbiegezange ADERER, 13 cm
Plate bending pliers ADERER, 13 cm



Artikel-Nr.
Cat. No.

31 505 Platten/Schrauben-Haltepinzette,
TITAN, 15 cm
Plates and screws holding forceps
TITANIUM, 15 cm





Artikel-Nr.
Cat. No.

31 507 Schraubendreher, 18 cm
selbsthaltend, für Kreuzschlitzschrauben
Screw-driver, 18 cm
self-holding, for cross head screws

31 508 Schraubendreher, 18 cm
selbsthaltend, für Vierkantschrauben
Screw-driver, 18 cm
self-holding, for square head screws



Artikel-Nr.
Cat. No.

31 509 Schraubendrehergriff
alleine, für alle Klingen
Screw-driver handle
only, for all blades



Artikel-Nr.
Cat. No.

31 510 Schraubendreher, 18 cm
selbsthaltend, für Kreuzschlitzschrauben
Screw-driver, 18 cm
self-holding, for cross head screws

31 511 Schraubendreher, 18 cm
selbsthaltend, für Vierkantschrauben
Screw-driver, 18 cm
self-holding, for square head screws

Artikel-Nr.
Cat. No.

31 513 Schraubendrehergriff
alleine, für alle Klingen
Screw-driver handle
only, for all blades



Artikel-Nr.
Cat. No.

31 514 Schraubendreherklinge
alleine, selbsthaltend, für Kreuzschlitzschrauben
Screw-driver blade
only, self-holding, for cross head screws



31 515 Schraubendreherklinge
alleine, selbsthaltend, für Vierkantschrauben
Screw-driver blade
only, self-holding, for square head screws



Artikel-Nr.
Cat. No.

31 518 Tiefenmesser, Messtiefe 50 mm
Depth gauge, measuring depth 50 mm





Artikel-Nr.
Cat. No.

Spiralbohrer mit Stryker-Ansatz
Twist Drill with Stryker Coupling

31 525 \varnothing 1,3 x 47 mm
für Schrauben bis 5 mm Länge
for screws up to 5 mm length

31 526 \varnothing 1,3 x 50 mm
für Schrauben bis 8 mm Länge
for screws up to 8 mm length

Spiralbohrer mit Dental-Ansatz
Twist Drill with Dental Coupling

31 527 \varnothing 1,3 x 31 mm
für Schrauben bis 5 mm Länge
for screws up to 5 mm length

31 528 \varnothing 1,3 x 34 mm
für Schrauben bis 8 mm Länge
for screws up to 8 mm length

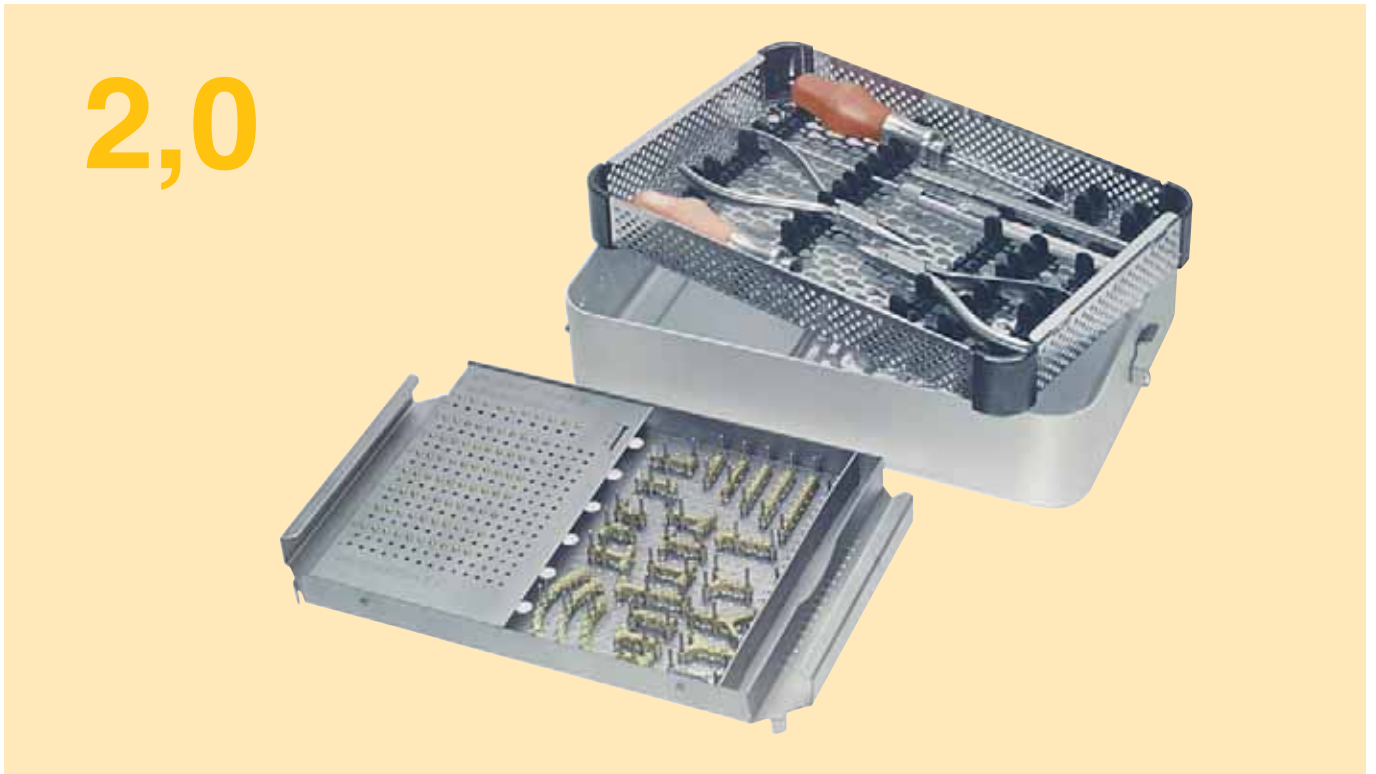

Artikel-Nr.
Cat. No.

32 000	Mini-Platten-Standard Set Standard Set Mini Plates komplett, bestehend aus: complete, consisting out of:
32 001	Sterilisier-Container 300 x 200 x 70 mm Sterilisation Container 300 x 200 x 70 mm
32 002	Rack für Instrumente / Rack for instruments
32 003	Rack für Platten und Schrauben, TITAN Rack for plates and screws, TITANIUM
32 500	Plattenschneidezange, mit Hartmetall, 18 cm Plate cutting pliers, with Tungsten Carbide inserts, 18 cm
32 502	Flachzange, 13,5 cm / Flat pliers, 13,5 cm
32 503	Plattenbiegezange ADERER, 13 cm Plate bending pliers ADERER, 13 cm
32 505	Platten/Schrauben-Haltepinzette, TITAN, 15 cm Plates and screws holding forceps, TITANIUM, 15 cm
32 507	Schraubendreher, selbsthaltend, 18 cm, für Kreuzschlitzschrauben Screw-driver, self-holding, 18 cm, for cross head screws
32 525	1x Spiralbohrer 1,5 x 50 mm mit Stryker-Ansatz 1x Twist drill 1,5 x 50 mm with Stryker coupling
32 526	1x Spiralbohrer 1,5 x 50 mm mit Stryker-Ansatz 1x Twist drill 1,5 x 50 mm with Stryker coupling

Platten, je 5 Stück / Plates, 5 each:

32 122	8-Loch / 8 holes
32 123	10-Loch / 10 holes

Artikel-Nr.
Cat. No.

32 124	12-Loch / 12 holes
32 157	4-Loch / 4 holes
32 158	4-Loch/ 4 holes
32 161	6-Loch / 6 holes
32 162	6-Loch / 6 holes
32 163	8-Loch / 8 holes
32 165	16-Loch / 16 holes
32 168	4-Loch, rechts / 4 holes, right
32 169	4-Loch, links / 4 holes, left
32 170	4-Loch, rechts / 4 holes, right
32 171	4-Loch, links / 4 holes, left
32 180	5-Loch / 5 holes
32 181	6-Loch / 6 holes
32 182	4-Loch / 4 holes
32 183	4-Loch / 4 holes
32 184	6-Loch / 6 holes
32 185	6-Loch / 6 holes
32 186	5-Loch / 5 holes
32 187	5-Loch / 5 holes
32 188	6-Loch / 6 holes
32 189	5-Loch / 5 holes
32 190	5-Loch / 5 holes
32 191	5-Loch / 5 holes

Schrauben, je 10 Stück / Screws, 10 each:

32 321	ø 2,0 x 5 mm
32 323	ø 2,0 x 7 mm
32 325	ø 2,0 x 9 mm
32 327	ø 2,0 x 11 mm
32 329	ø 2,0 x 13 mm
32 331	ø 2,0 x 15 mm
32 333	ø 2,0 x 17 mm
32 335	ø 2,3 x 7 mm Notfallschraube/Emergency screw

Gerne können Sie Ihr individuelles Set zusammenstellen.
Wir passen die Lagerungsracks entsprechend an.

You can always compose your individual set.
We will adapt the racks accordingly.

5



Nr./No.:

32 101
4-Loch
4 holes

32 102
4-Loch
4 holes

32 103
4-Loch
4 holes

32 104
6-Loch
6 holes

32 105
8-Loch
8 holes

5



Nr./No.:

32 106
4-Loch, rechts
4 holes, right

32 107
4-Loch, links
4 holes, left

32 108
4-Loch, rechts
4 holes, right

32 109
4-Loch, links
4 holes, left

32 110
4-Loch, rechts
4 holes, right

32 111
4-Loch, links
4 holes, left

5

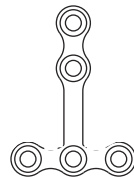
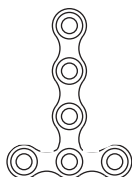

Nr./No.:

32 112
5-Loch, rechts
5 holes, right

32 113
5-Loch, links
5 holes, left

32 114
6-Loch
6 holes

32 115
5-Loch
5 holes

32 116
6-Loch
6 holes

5

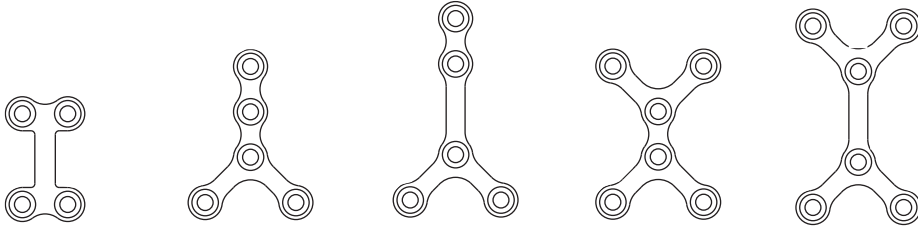

Nr./No.:	32 117 4-Loch 4 holes	32 118 5-Loch 5 holes	32 119 5-Loch 5 holes	32 120 6-Loch 6 holes	32 121 6-Loch 6 holes
----------	------------------------------------	------------------------------------	------------------------------------	------------------------------------	------------------------------------

5

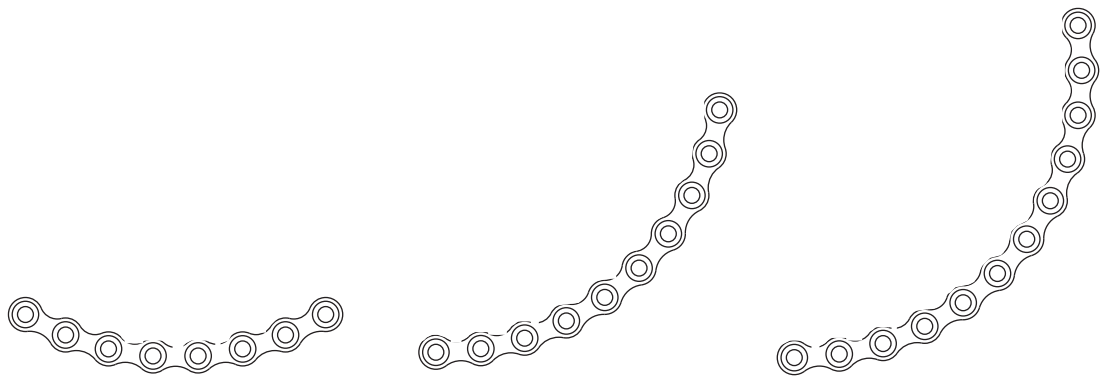

Nr./No.:	32 122 8-Loch 8 holes	32 123 10-Loch 10 holes	32 124 12-Loch 12 holes
----------	------------------------------------	--------------------------------------	--------------------------------------

5

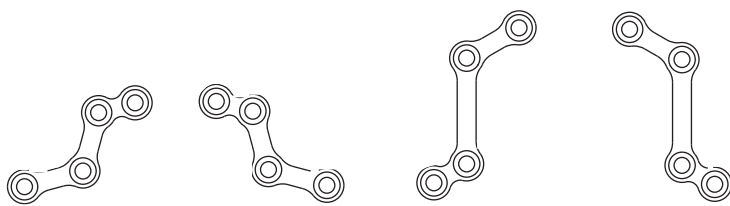

Nr./No.:	32 125 4-Loch, rechts 4 holes, right	32 126 4-Loch, links 4 holes, left	32 127 4-Loch, rechts 4 holes, right	32 128 4-Loch, links 4 holes, left
----------	---	---	---	---

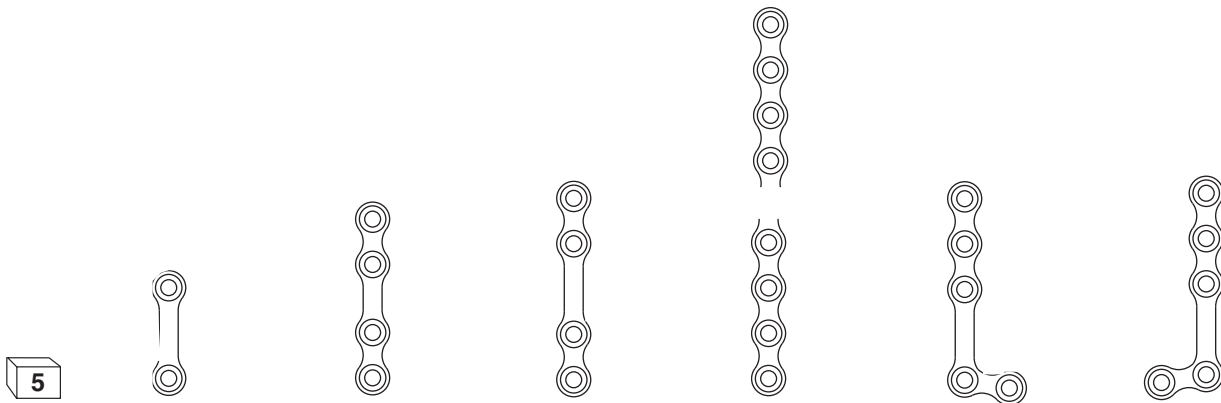

Nr./No.:	32 136 2-Loch 2 holes	32 137 4-Loch 4 holes	32 138 4-Loch 4 holes	32 139 40-Loch 40 holes	32 140 5-Loch, rechts 5 holes, right	32 141 5-Loch, links 5 holes, left
-----------------	------------------------------------	------------------------------------	------------------------------------	--------------------------------------	---	---

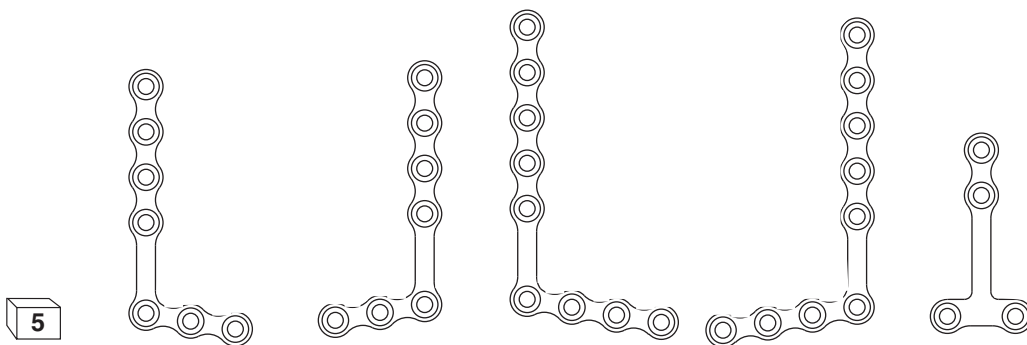

Nr./No.:	32 142 7-Loch, rechts 7 holes, right	32 143 7-Loch, links 7 holes, left	32 144 9-Loch, rechts 9 holes, right	32 145 9-Loch, links 9 holes, left	32 146 4-Loch 4 holes
-----------------	---	---	---	---	------------------------------------

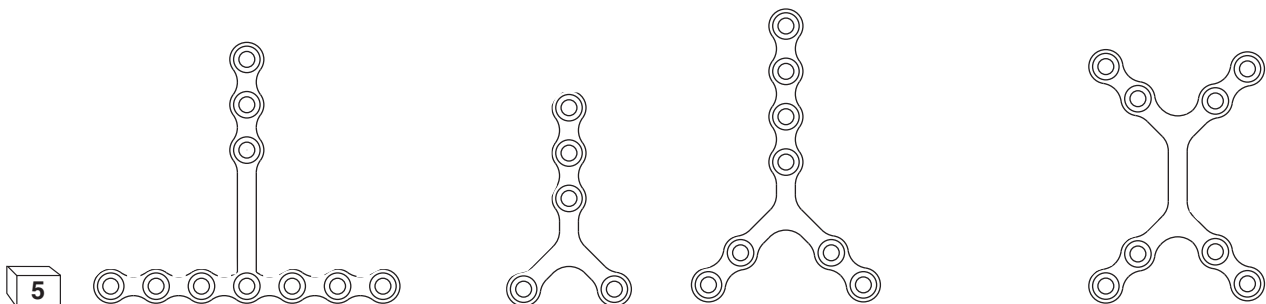

Nr./No.:	32 147 10-Loch 10 holes	32 148 5-Loch 5 holes	32 149 8-Loch 8 holes	32 150 8-Loch 8 holes
-----------------	--------------------------------------	------------------------------------	------------------------------------	------------------------------------

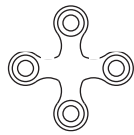

Artikel-Nr.
 Cat. No.

32 151

4-Loch
 4 holes

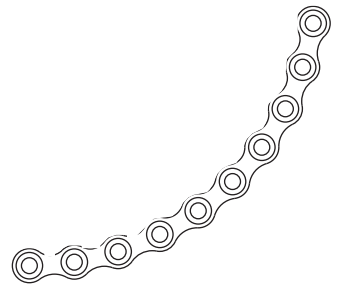
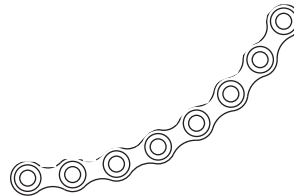
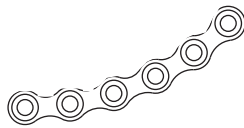

Nr./No.:
Orbita-Platten
Orbital Plates

32 152
 6-Loch
 6 holes

32 153
 8-Loch
 8 holes

32 154
 10-Loch
 10 holes

5

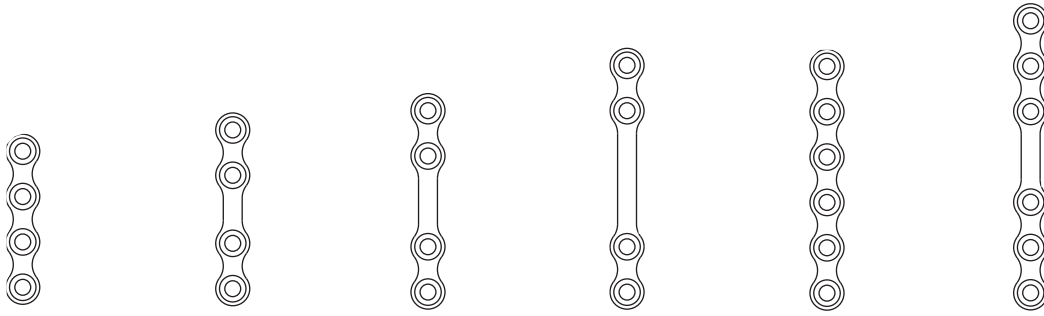

Nr./No.:	32 157 4-Loch 4 holes	32 158 4-Loch 4 holes	32 159 4-Loch 4 holes	32 160 4-Loch 4 holes	32 161 6-Loch 6 holes	32 162 6-Loch 6 holes
----------	------------------------------------	------------------------------------	------------------------------------	------------------------------------	------------------------------------	------------------------------------

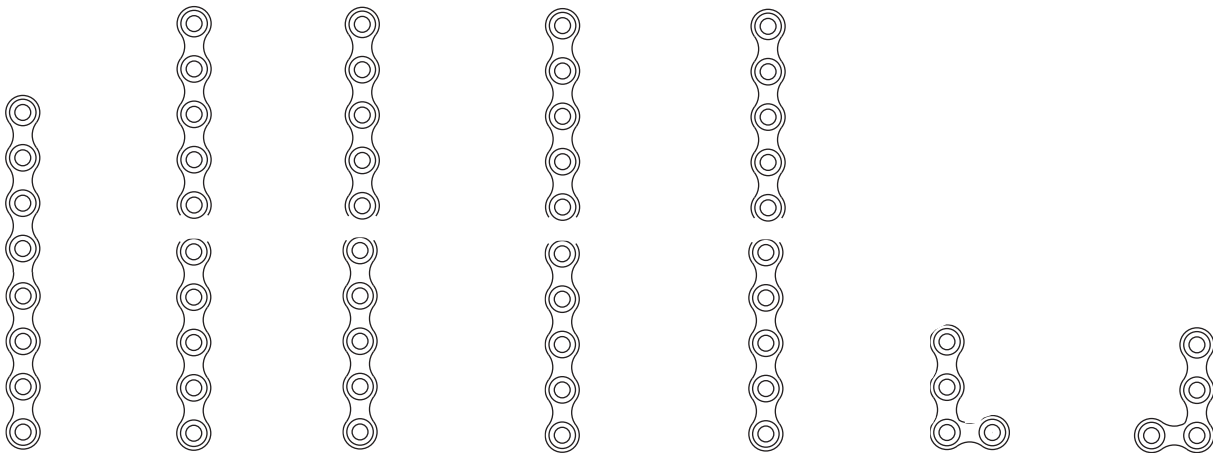

32 163 8-Loch 8 holes	32 164 12-Loch 12 holes	32 165 16-Loch 16 holes	32 166 24-Loch 24 holes	32 167 40-Loch 40 holes	32 168 4-Loch, rechts 4 holes, right	32 169 4-Loch, links 4 holes, left
------------------------------------	--------------------------------------	--------------------------------------	--------------------------------------	--------------------------------------	---	---

5

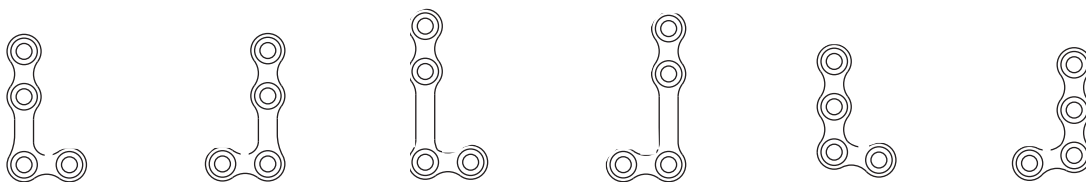

Nr./No.:	32 170 4-Loch, rechts 4 holes, right	32 171 4-Loch, links 4 holes, left	32 172 4-Loch, rechts 4 holes, right	32 173 4-Loch, links 4 holes, left	32 174 4-Loch, rechts 4 holes, right	32 175 4-Loch, links 4 holes, left
----------	---	---	---	---	---	---

5

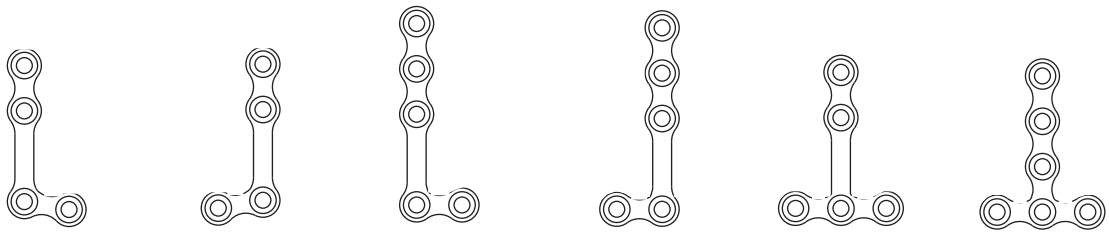

Nr./No.:	32 176 4-Loch, rechts 4 holes, right	32 177 4-Loch, links 4 holes, left	32 178 5-Loch, rechts 5 holes, right	32 179 5-Loch, links 5 holes, left	32 180 5-Loch 5 holes	32 181 6-Loch 6 hole
----------	---	---	---	---	------------------------------------	-----------------------------------

5

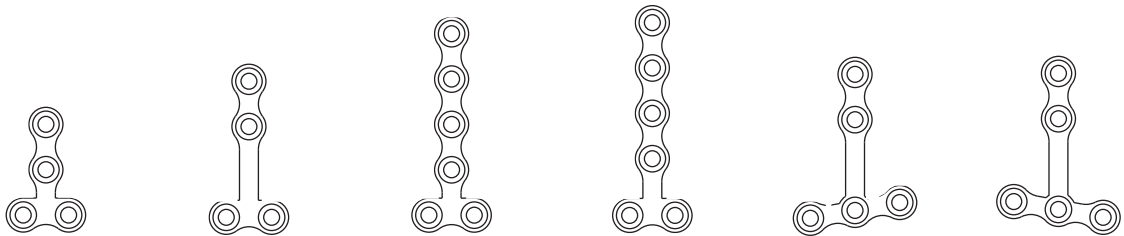

Nr./No.:	32 182 4-Loch 4 holes	32 183 4-Loch 4 holes	32 184 6-Loch 6 holes	32 185 6-Loch 6 holes	32 186 5-Loch 5 holes	32 187 5-Loch 5 holes
----------	------------------------------------	------------------------------------	------------------------------------	------------------------------------	------------------------------------	------------------------------------

5

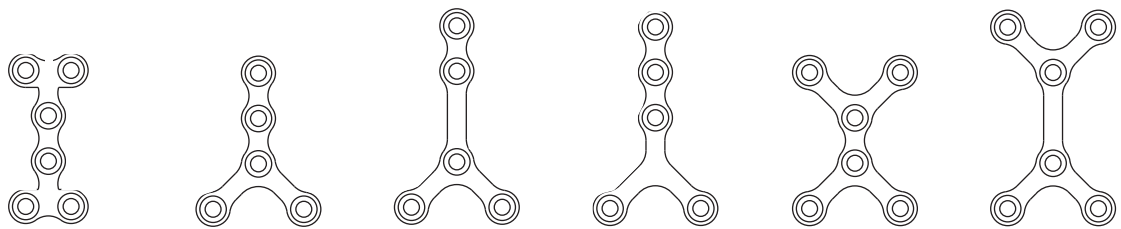

Nr./No.:	32 188 6-Loch 6 holes	32 189 5-Loch 5 holes	32 190 5-Loch 5 holes	32 191 5-Loch 5 holes	32 192 6-Loch 6 holes	32 193 6-Loch 6 holes
----------	------------------------------------	------------------------------------	------------------------------------	------------------------------------	------------------------------------	------------------------------------

5

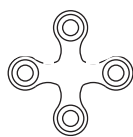
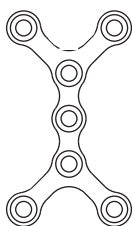

1

für Trepanation
 for trepanation

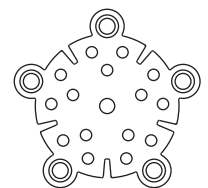
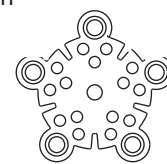
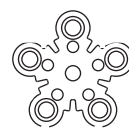

Nr./No.:	32 194 7-Loch 7 holes	32 195 4-Loch 4 holes	Bohrlochplatten Burr hole plates	32 196 ø 7 mm ø 7 mm	32 197 ø 10 mm ø 10 mm	32 198 ø 14 mm ø 14 mm
----------	------------------------------------	------------------------------------	---	-----------------------------------	-------------------------------------	-------------------------------------

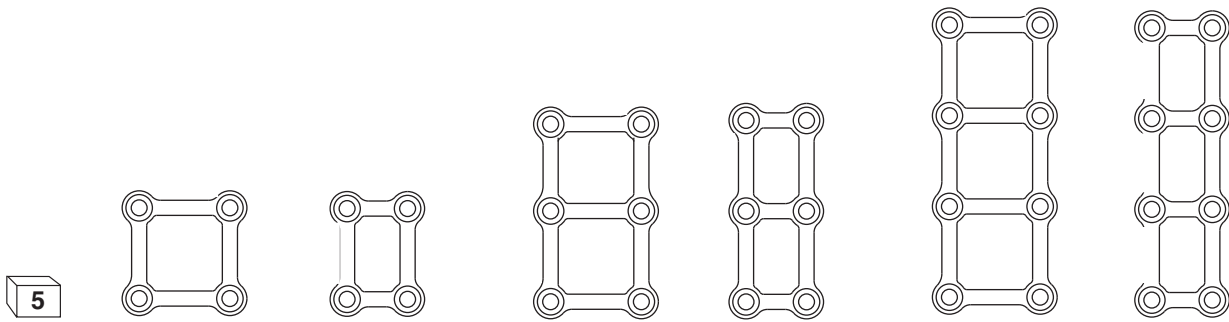

Nr./No.:	32 199 2x2-Loch 2x2 holes	32 200 2x2-Loch 2x2 holes	32 201 3x2-Loch 3x2 holes	32 202 3x2-Loch 3x2 holes	32 203 4x2-Loch 4x2 holes	32 204 4x2-Loch 4x2 holes
----------	--	--	--	--	--	--

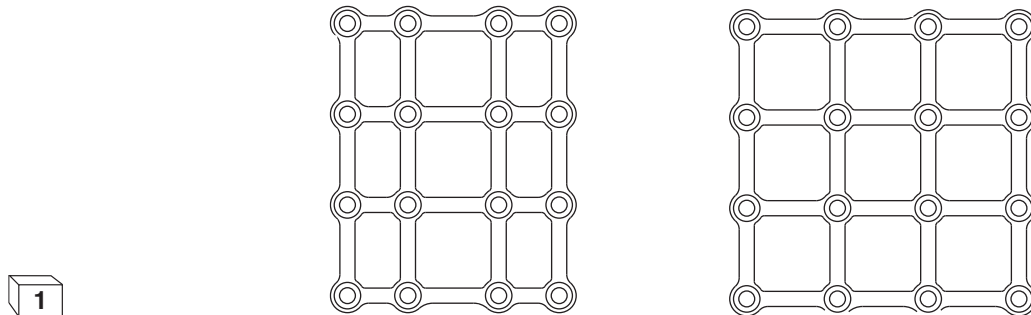

Nr./No.:	32 205 4x4-Loch 4x4 holes	32 206 4x4-Loch 4x4 holes
----------	--	--

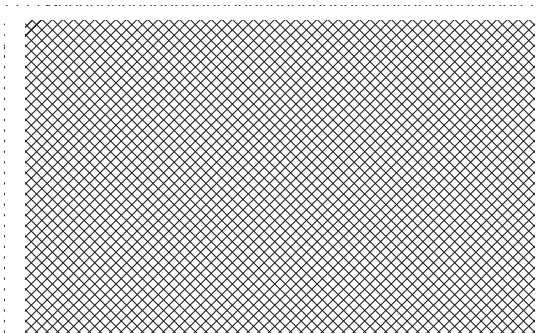

1 Artikel-Nr.
Cat. No. **Gitter-Platten, TITAN**
Mesh Plates, TITANIUM

32 251	60 x 60 x 0,1 mm
32 252	120 x 60 x 0,1 mm
32 253	120 x 120 x 0,1 mm
32 254	60 x 60 x 0,2 mm
32 255	120 x 60 x 0,2 mm
32 256	120 x 120 x 0,2 mm
32 257	80 x 50 x 0,3 mm

10 Artikel-Nr.
Cat. No. **TITAN-Draht**
TITANIUM wires

32 270	0,4 mm
32 271	0,5 mm
32 272	0,6 mm



Artikel-Nr.
Cat. No.

Schlitz/Pin
Single slot

32 310	ø 2,0 x 4 mm
32 311	ø 2,0 x 5 mm
32 312	ø 2,0 x 7 mm
32 313	ø 2,0 x 9 mm
32 314	ø 2,0 x 11 mm
32 315	ø 2,0 x 13 mm
32 316	ø 2,0 x 15 mm
32 317	ø 2,0 x 17 mm



32 318

Notfallschraube
Emergency screw
ø 2,3 x 7 mm



Artikel-Nr.
Cat. No.

Kreuzschlitz
Cross head

32 320	ø 2,0 x 4 mm
32 321	ø 2,0 x 5 mm
32 323	ø 2,0 x 7 mm
32 325	ø 2,0 x 9 mm
32 327	ø 2,0 x 11 mm
32 329	ø 2,0 x 13 mm
32 331	ø 2,0 x 15 mm
32 333	ø 2,0 x 17 mm

Notfallschrauben
Emergency screws

32 334	ø 2,3 x 5 mm
32 335	ø 2,3 x 7 mm



Artikel-Nr.
Cat. No.

Vierkant
Square head

32 340	ø 2,0 x 4 mm
32 341	ø 2,0 x 5 mm
32 342	ø 2,0 x 7 mm
32 343	ø 2,0 x 9 mm
32 344	ø 2,0 x 11 mm
32 345	ø 2,0 x 13 mm
32 346	ø 2,0 x 15 mm
32 347	ø 2,0 x 17 mm

Notfallschrauben
Emergency screws

32 348	ø 2,3 x 5 mm
32 349	ø 2,3 x 7 mm

Artikel-Nr.
Cat. No.

32 500 Plattenschneidezange
18 cm, mit Hartmetall
Plate cutting pliers,
18 cm, with Tungsten Carbide inserts



Artikel-Nr.
Cat. No.

32 502 Flachzange, 13,5 cm
Flat pliers, 13,5 cm





Artikel-Nr.
Cat. No.

32 503 Plattenbiegezange ADERER, 13 cm
Plate bending pliers ADERER, 13 cm



Artikel-Nr.
Cat. No.

32 504 Plattenbiegezange
13,5 cm, mit Stift
Plate bending pliers
13,5 cm, with pin



Artikel-Nr.
Cat. No.

32 505 Platten/Schrauben-Haltepinzette
TITAN, 15 cm
Plates and screws holding forceps
TITANIUM, 15 cm

Artikel-Nr.
Cat. No.

32 506 Schraubendreher, 18 cm
mit Haltevorrichtung, für Schlitz/Pin-Schrauben
Screw-driver, 18 cm
with holding sleeve, for single slot screws



Artikel-Nr.
Cat. No.

32 507 Schraubendreher, 18 cm,
selbsthaltend, für Kreuzschlitzschrauben
Screw-driver, 18 cm,
self-holding, for cross head screws



32 508 Schraubendreher, 18 cm,
selbsthaltend, für Vierkantschrauben
Screw-driver, 18 cm,
self-holding, for square head screws



Artikel-Nr.
Cat. No.

32 509 Schraubendrehergriff
alleine, für alle Klingen
Screw-driver handle
only, for all blades





Artikel-Nr.
Cat. No.

- | | |
|---------------|---|
| 32 510 | Schraubendreher, 18 cm
selbsthaltend, für Kreuzschlitzschrauben
Screw-driver, 18 cm
self-holding, for cross head screws |
| 32 511 | Schraubendreher, 18 cm,
selbsthaltend, für Vierkantschrauben
Screw-driver, 18 cm,
self-holding, for square head screws |
| 32 512 | Schraubendreher, 18 cm
mit Haltevorrichtung, für Schlitz/Pin-Schrauben
Screw-driver, 18 cm
with holding sleeve, for single slot screws |



Artikel-Nr.
Cat. No.

- | | |
|---------------|--|
| 32 513 | Schraubendrehergriff
alleine, für alle Klingen
Screw-driver handle
only, for all blades |
|---------------|--|



Artikel-Nr.
Cat. No.

- | | |
|---------------|---|
| 32 514 | Schraubendreherklinge
alleine, selbsthaltend, für Kreuzschlitzschrauben
Screw-driver blade
only, self-holding, for cross head screws |
| 32 515 | Schraubendreherklinge
alleine, selbsthaltend, für Vierkantschrauben
Screw-driver blade
only, self-holding, for square head screws |
| 32 516 | Schraubendreherklinge
alleine, für Schlitz/Pinschrauben
Screw-driver blade
only, for single slot screws |

Artikel-Nr.
Cat. No.

32 517 Schraubenhaltvorrichtung
für Schlitz/Pin
Screw-holding device
for Single slot



Artikel-Nr.
Cat. No.

32 518 Tiefenmesser, Messtiefe 50 mm
Depth gauge, measuring depth 50 mm



Artikel-Nr.
Cat. No.

32 519 Transbuccale Bohrhilfe
für Schraubendreher mit Haltevorrichtung
Transbuccal drilling guide
for screw-driver with holding sleeve

32 520 Transbuccale Bohrhilfe
für Schraubendreher ohne Haltevorrichtung
Transbuccal drilling guide
for screw-driver without holding sleeve





Artikel-Nr.
Cat. No.

Spiralbohrer mit Stryker-Ansatz
Twist Drill with Stryker Coupling

32 525	ø 1,5 x 50 mm für Schrauben bis 7 mm Länge for screws up to 7 mm length
32 526	ø 1,5 x 50 mm für Schrauben bis 20 mm Länge for screws up to 20 mm length
32 527	ø 1,5 x 70 mm für Schrauben bis 7 mm Länge for screws up to 7 mm length
32 528	ø 1,5 x 105 mm für Schrauben bis 20 mm Länge for screws up to 20 mm length

Technische Änderungen vorbehalten.

Dieser Prospekt darf ausschließlich zum An- und Verkauf unserer Erzeugnisse verwendet werden. Kein Teil des Prospekts darf ohne schriftliche Genehmigung durch uns in irgendeiner Form reproduziert werden.

© Rebstock Instruments GmbH

Technical alterations reserved.

This leaflet is to be used for no other purpose than buying and selling our products. No part of this leaflet may be reproduced in any form without prior written permission from our company.

© Rebstock Instruments GmbH

REBSTOCK
Precision made in Germany

Rebstock Instruments GmbH
In Breiten 12 · D-78589 Dürbheim/Tuttlingen · Germany
Tel.: (+49) 0 74 24 / 67 34 · Fax: (+49) 0 74 24 / 43 34
e-mail: rebstock-instrumente@t-online.de
Internet: <http://www.rebstock.de>

← INDEX

